

EDDYSTONE

“ALL WORLD SIX” RECEIVER

(Model 710)

Instruction Manual

The Eddystone “All World Six” receiver has been developed specially for the listener who lacks a mains electricity supply and requires a battery-operated receiver which will give the nearest possible approach to mains performance. A special feature of the “All World Six” is the low current consumption — only 2.5 amperes (average) from a 6 volt accumulator. The H.T. supply is derived from a vibrator and no H.T. battery is required.

The following are the ranges covered :

- Range 1 ... 30.6 to 10.5 Megacycles.
- Range 2 ... 10.6 to 3.7 Megacycles.
- Range 3 ... 3.8 to 1.4 Megacycles.
- Range 4 ... 205 to 620 Metres.

The fifth position of the selector switch (marked “G”) is for use when playing records. It renders inoperative the radio section of the receiver.

The recognised broadcast bands are marked in red and the amateur bands in blue. The special mechanical bandspread system is explained in detail overleaf.

The output circuit is of the push-pull type ; negative feed-back is incorporated and is automatically adjusted to the strength of the incoming signal ; the speaker is of the latest type, with a high flux density magnet ; and, as a result, the quality of reproduction is excellent.

The “All World Six” is finished for tropical service and the component parts will give long and reliable service.

INSTALLATION DETAILS

The receiver has been aligned, calibrated and thoroughly tested before despatch and is ready for immediate use.

The first essential is an aerial — and the better the aerial, the better the results you will obtain. For general reception, a wire between 40 and 60 feet in length, erected as high and as clear as possible, will give excellent results. On short waves, special aerial systems may be employed with advantage.

A single wire aerial is connected to the terminal marked "A" at the rear of the receiver, a good earth being attached to the terminal marked "AE." When a dipole (doublet) aerial is used, the shorting strap between "AE" and chassis is removed and the two ends of the feeder connected to "AE" and "A."

The ends of the heavy cable are connected to a 6 volt accumulator, observing correct polarity, red to positive, blue to negative. The greater the capacity of the accumulator, the longer it will provide service on one charge. In any case, the capacity (actual) should not be less than 40 ampere-hours.

The tone control knob on the left switches on the receiver. After a warming-up period of 20 seconds or so, stations are tuned in by rotation of the large right-hand knob, using the small knob on the extreme right to adjust the volume.

CURRENT CONSUMPTION.

The average drain from a 6 volt accumulator is 2.8 amperes with the dial light on, 2.5 amperes with the dial light off. The greater the capacity of the battery, the longer will the receiver run on one charge. For example, a 100 ampere-hour battery will operate the receiver for between 30 and 40 hours.

EXTENSION SPEAKER.

An extension speaker may be connected to the terminals marked "L.S." at the rear. The wires coming from the interior of the set should be disconnected if it is desired to mute the internal speaker. The extension speaker should have an impedance of between 2 and 3 ohms — the Eddystone Cat. No. 697 is recommended for the purpose.

USE OF A PICK-UP.

Good results will be secured with any of the standard types of high impedance pick-up. The lead to the latter should preferably be screened, and the outer braid connected to the earthed terminal (the one on the Left, looking from the rear).

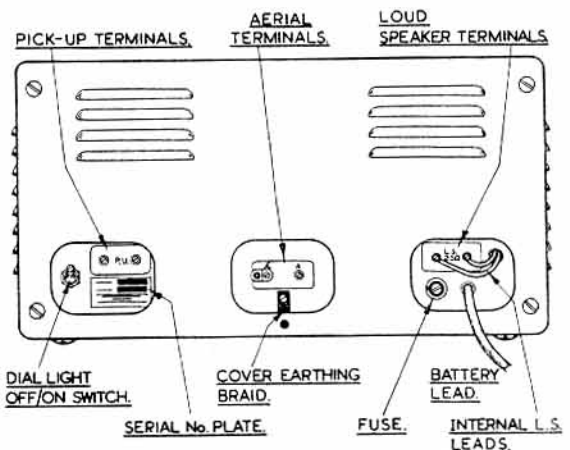

DIAL LIGHT.

At the rear of the receiver will be found a switch, the purpose of which is to enable the dial lamp to be switched off, once the desired station has been tuned in. An appreciable saving in battery current is thereby effected. The lamp is of the M.B.C. type rated at 6 volts 1.8 watts.

MECHANICAL VIBRATION.

The "All World Six" Receiver utilises a vibrator unit to supply high tension, and precautions have been taken to reduce the slight mechanical vibration to a negligible value. However, if the receiver is placed directly on a wooden table, the latter may have a sounding-board effect and bring up the vibration. For this reason, we recommend that the receiver be placed on a felt mat. Rubber should not be used, to avoid possible chemical effects.

FUSE.

The fuse at the rear is fitted in series with the vibrator power unit. The rating is 10 amperes, a value much greater than the normal current flowing but rendered necessary because of the initial surge.

It is most unlikely that you will experience any trouble with the receiver, but if at any time it fails to work SWITCH OFF, until the reason has been ascertained. One test is to observe the dial light — if dim, then either the accumulator is low and requires charging, or an internal fault exists.

FINE TUNING INDICATOR.

The fine tuning indicator will be found valuable for making a permanent log, for future reference, of the exact settings of preferred stations.

The indicator is read in conjunction with the inner semi-circular scale, which is traversed by the main pointer and reads from "0" to "9." The principle of operation is as follows: with the main pointer at zero (extreme left-hand side of the dial) the scale will also show zero. On rotating the main tuning knob, it will be seen that the major figures at the top of the F.T.I. scale progressively increase until figure "0" again appears. The main pointer will then coincide with "1" on the inner scale.

The fine lines of the F.T.I. scale are sub-divided into single units. As the scale rotates, the hair line registers against the intersections of the horizontal marks and vertical lines. In effect the inner scale reads "hundreds," the numbers at the top of the F.T.I. scale "tens" and the horizontal lines, single units, giving a total number of 900 units for a complete swing of the main pointer from one end to the other.

An example will make the foregoing clearer. Suppose a station is tuned in at approximately mid-scale on band 1, representing a frequency near 19 Mc/s. The main pointer will be between figures "4" and "5" on the inner scale, indicating that the final number will be between 400 and 500. The hair line indicator will intersect the curved line marked 60 at the top. It may actually intersect against the second horizontal marker down, giving an exact figure of "62." The final reference number will then be "462."

SERVICING INSTRUCTIONS

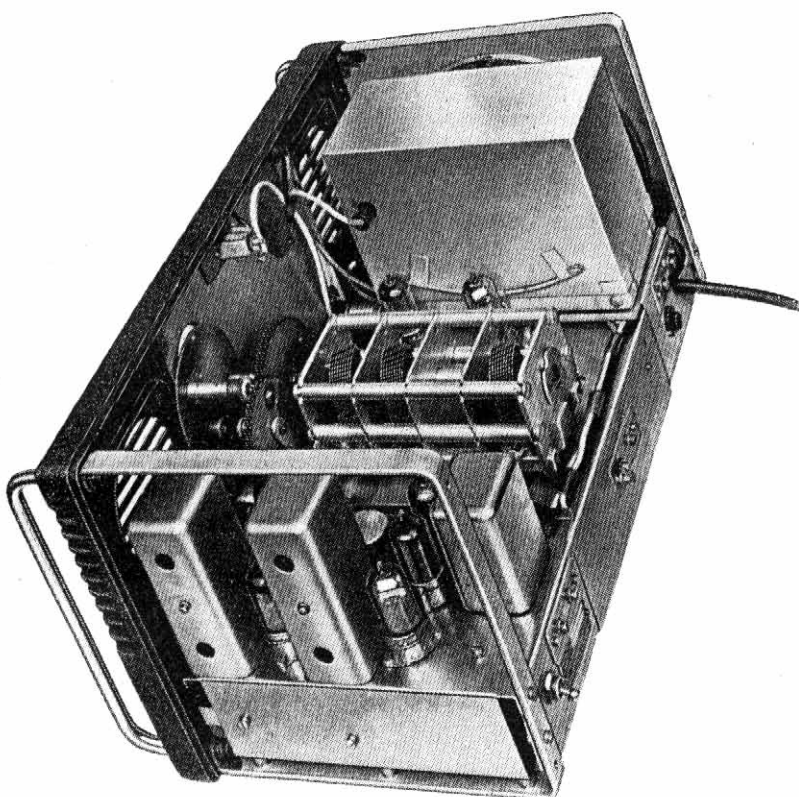

Fig. 4.—Interior view of "All World Six."

Should the receiver fail to function at any time, first ensure that the battery connections are clean and tight, the battery not run down, and the fuse intact. The light given by the dial bulb will give a useful indication of the state of the battery — if, on switching on, it lights up normally but then rapidly dies down, the battery definitely requires re-charging. If the light is bright and steady the fault must be looked for elsewhere.

It will be well to check the soundness of the loudspeaker connections (internal and/or external) and likewise the aerial and earth connections. Further work entails the removal of the cabinet, which is secured by the four large screws at the rear.

A faint red glow should be visible from each of the valve heaters and a valve in good condition should feel warm after being in use for a while. Care should be used when changing a valve, to avoid damage to the glass base.

The vibrator unit is completely screened in a metal box, in which is contained the transformer, smoothing and filter components and the selenium rectifier. A check should be made between the higher H.T. positive outlet and chassis, across which points a potential of about 132 volts should exist a reading much less than this indicates an internal fault.

The rated life of the vibrator unit is 1,000 hours, but, in practice, this time will be much exceeded. When ordering a new vibrator unit, a 4-pin plug-in type NS/6 should be specified.

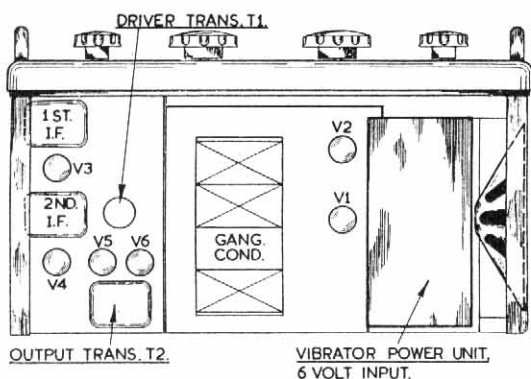

Fig. 3.—Plan view of receiver in outline.

ALIGNMENT.

The following instructions are based on the assumption that the receiver has suffered no major misalignment.

Although minor adjustments may be carried out without them, it is definitely more satisfactory, for proper alignment, to use test instruments, the following being essential :

1. A Signal Generator, fitted with a calibrated attenuator and having internal modulation. The frequency range should cover that of the receiver and the intermediate frequency. The Signal Generator should preferably be isolated with $\cdot 01 \mu\text{F}$ condensers, a 1 megohm resistor being connected across the leads, on the receiver side, to ensure D.C. continuity. For the sake of brevity the Signal Generator is referred to in the following notes as the Sig. Gen. When aligning the R.F. stages, a dummy aerial, suitable for high frequencies, should be interposed between the direct output of the generator and the aerial terminals of the receiver. Should no dummy aerial be supplied with the generator, a 400 ohm carbon resistor will serve, fitted in series with the high potential lead.
2. An audio output meter, calibrated in milliwatts and decibels to match an impedance of 2.5 ohms.
3. A non-metallic trimming tool, with a screwdriver shaped end, for adjusting coil cores, etc. The Eddystone Cat. No. 122T tool is suitable.

The receiver should be removed from its cabinet (by unscrewing the four screws at the rear) and stood on its left-hand end, face to the operator, taking care not to damage the speaker. Connect the output meter across the speaker terminals, leaving the speaker connected, as this is helpful.

I.F. CIRCUITS.

The intermediate frequency is 450 Kc/s. The I.F. Transformers are well designed and constructed and are unlikely to drift off frequency over long periods.

Before commencing alignment, allow the receiver and the Sig. Gen. to warm up for at least ten minutes, to minimise frequency drift. Set the Tone and Volume Controls fully clockwise and Selector Switch to Band 4.

The Sig. Gen. leads should be clipped, one to the stator of the centre section of the gang condenser, the other to the coil box casting. The Sig. Gen. should be adjusted to a frequency of 450 Kc/s., 30% modulated, with the attenuator set to give an output in the region of 100 microvolts.

Then proceed to adjust, with the insulated trimming tool, the cores in the I.F. Transformers. The Sig. Gen. output should be reduced as necessary. When maximum output has been secured the attenuator should indicate less than 80 microvolts for a 50 milliwatt output, as shown on the meter with the speaker disconnected. Should the attenuator reading be higher than this, it is possible that the valve emission is beginning to fail.

R.F. AND OSCILLATOR RE-ALIGNMENT.

For the sake of completeness, the instructions which follow give the whole procedure for re-alignment of the radio frequency, frequency changer and oscillator sections. It is emphasised, however, that usually all that will be necessary is slight adjustment of the trimmer condensers and this operation can be carried out without removing the cover of the coil box. In the first place, therefore, only those instructions in the following paragraphs dealing with trimmer adjustment should be attended to. If the alignment is still not wholly satisfactory, the coil cores may be adjusted, but considerable care is called for to ensure that proper tracking is maintained.

R.F. AND OSCILLATOR RE-ALIGNMENT.

For the sake of completeness, the instructions which follow give the whole procedure for re-alignment of the radio frequency, frequency changer and oscillator sections. It is emphasised, however, that usually all that will be necessary is slight adjustment of the trimmer condensers and this operation can be carried out without removing the cover of the coil box. In the first place, therefore, only those instructions in the following paragraphs dealing with trimmer adjustment should be attended to. If the alignment is still not wholly satisfactory, the coil cores may be adjusted, but considerable care is called for to ensure that proper tracking is maintained.

OSCILLATOR STAGES.

On each band, the oscillator frequency is 450 Kc/s. higher than the signal frequency.

The Sig. Gen. leads are connected, via the dummy aerial, to the aerial and earth terminals. Remove the lid of the coil box, taking care not to drag it across the small trimmer condensers, to avoid damage to the small vanes.

Adjust the tuning to 12 Mc/s. on Band 1, and set the Sig. Gen. to give an output of 50 microvolts (or less) on the same frequency.

It is desirable to point out here that very few Signal Generators are calibrated to an accuracy of better than 1%, which means in practice that at a setting of 12 Mc/s. the frequency may be plus or minus 120 Kc/s. in error. If only a small discrepancy is found between the Sig. Gen. calibration and the receiver calibration, it will be well not to readjust the oscillator frequency. To ensure absolutely correct calibration, it is necessary to use a Crystal Calibrator, incorporating a close tolerance 1000 Kc/s. Crystal, for the final setting of the oscillator circuit. Such an instrument (for A.C. Mains only) is manufactured by Eddystone (Cat. No. 690) and will be found indispensable where accurate calibration of any type of receiver is called for.

If found necessary, therefore, proceed to adjust Core No. 3 until the signal is audible and maximum output is indicated. Next, change to Band 2, adjust Sig. Gen. and tuning pointer to a frequency of 4 Mc/s. and trim Core No. 6. Then proceed to adjust Core No. 9 on Band 3 at 1.5 Mc/s., and Core No. 12 on Band 4 with the Sig. Gen. at 550 Kc/s. and Receiver dial at 545.5 metres.

A similar procedure is followed at the higher frequency end of each band, using the frequencies set out in the panel below, but this time adjusting the Trimmer Condensers. On Bands 1 and 2 (at 28 and 9 Mc/s.) it may be possible to find two settings of the trimmers at which the signal is audible — the correct one is with the trimmer capacitance at its lowest, i.e., with the black line on the rotor nearest to the front of the receiver.

CORES	Band	Frequency	Osc.	F.C.	R.F.
	1	12 Mc/s.	3	2	1
	2	4 Mc/s.	6	5	4
	3	1.5 Mc/s.	9	8	7
	4	550 Kc/s. (545.5 metres)	12	11	10

TRIMMERS	1	28 Mc/s.	3	2	1
	2	9 Mc/s.	6	5	4
	3	3.2 Mc/s.	9	8	7
	4	250 metres (1200 Kc/s.)	12	11	10

The adjustments of the cores and trimmers affect each other slightly and it is therefore advisable to repeat the foregoing procedure once or twice. (continued on back page)

R.F. AND F.C. STAGES.

The procedure adopted in trimming the radio-frequency and frequency changer input circuits is very similar to that described above for the oscillator stage. For example, on Band 4, the receiver is tuned for maximum output on the meter with the Sig. Gen. set at 550 Kc/s., the attenuator being adjusted to provide a reasonable reading. Cores No. 11 (F.C.) and 10 (R.F.) are then moved until maximum output is indicated.

At the high frequency end of Band 4, a frequency of 1.2 Mc/s. (250 metres) is employed and Trimmers Nos. 11 and 10 adjusted for peak output. As with the oscillator, the process should be repeated.

Replacing the lid of the coil box will cause a very slight alteration of frequency at the high frequency end of the bands but it will only be appreciable on Bands 1 and 2. A further slight re-adjustment of Trimmers 3 and 6 will correct this — the trimmers are accessible through holes in the lid after it has been screwed in position.

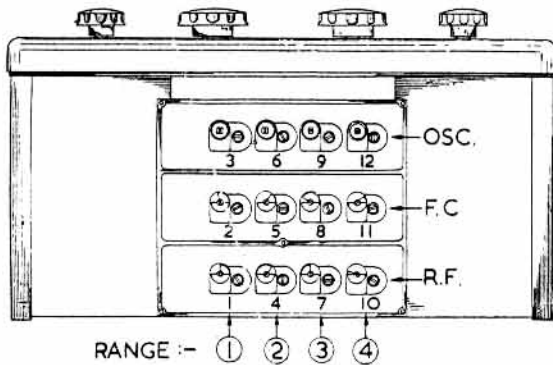

VOLTAGE VALUES

The voltages are between the point indicated and the chassis. Set the receiver at 400 metres on Range 4, with the aerial shorted out, volume control and tone control turned fully clockwise. Two sets of values are given using different meters as shown. It will be evident that the actual voltage indicated depends on the meter employed. A tolerance of plus or minus 5% should be allowed on the values given.

Circuit Ref.	Weston (1000 ohms/Volt)	Avo (Model 40)
A	1.2	1.0
B	117.0	117.0
C	70.0	65.0
D	55.0	52.0
E	116.0	113.0
F	1.2	1.1
G	78.0	72.0
H	2.8	2.3
J	116.0	114.0
K	80.0	62.0
L	12.0	6.0
M	22.0	12.0
N	0.8	0.5
O	117.0	115.0
P	132.0	130.0
Q	132.0	130.0
R	134.0	132.0
S	117.0	115.0

STRATTON & CO., LTD.

EDDYSTONE WORKS, ALVECHURCH ROAD
WEST HEATH, BIRMINGHAM, 31



Cables : "STRATNOID" Birmingham

Telephone : PRlory 2231-2-3-4

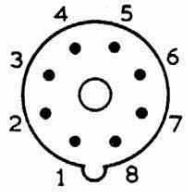
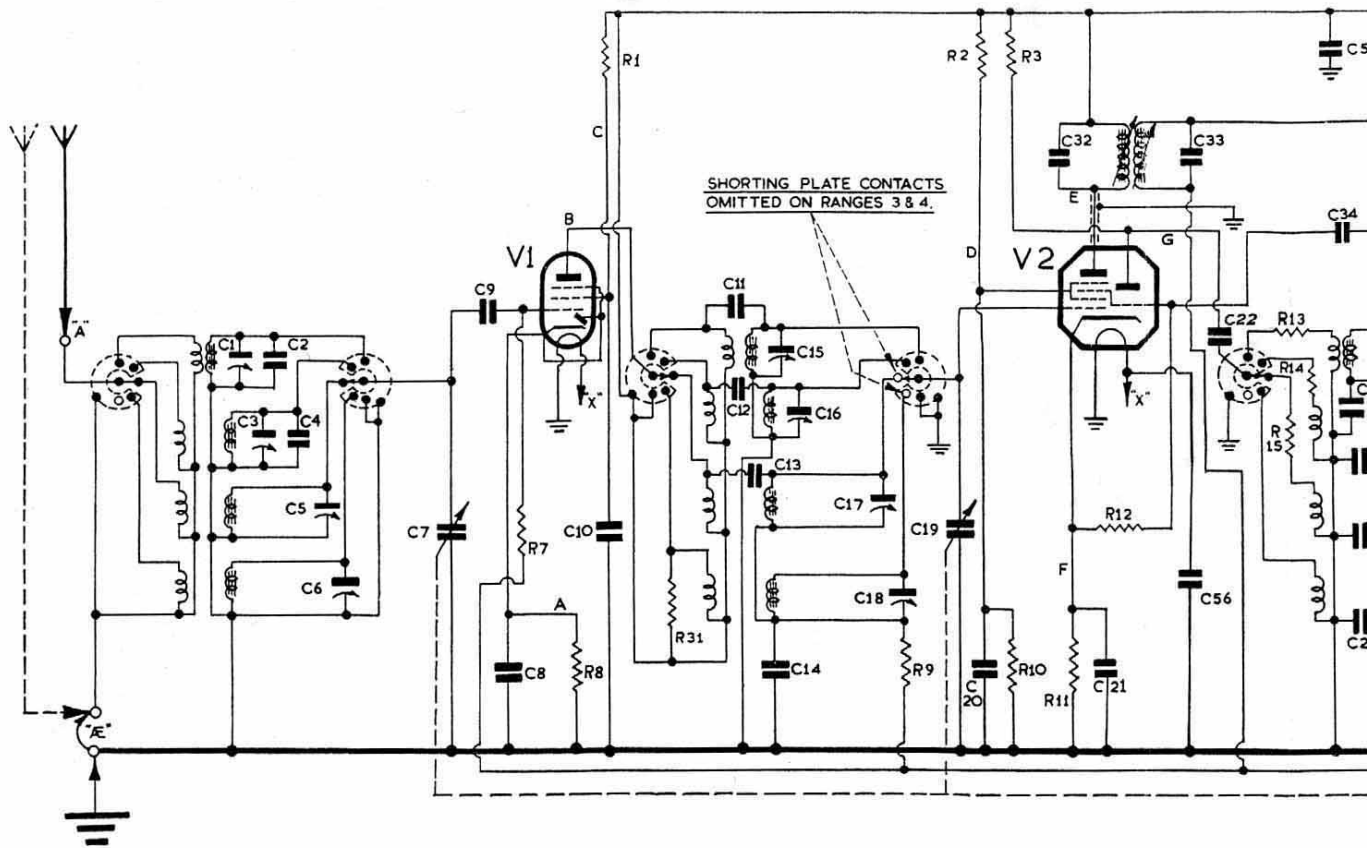

VALVES		1	2	3	4	5	6	7	8
V1, 3, 4.	EAF 42	H	A	AD	G3	G2	G1	KS	H
V2.	ECH 42	H	AH	AT	G3	G2	G1	K	H
V5, 6.	EL 42	H	A	K	G3	G	G1	K	H

ON/OFF

"ALL-WORLD SIX" RECEIVER.

The switch in series with the dial lamp connects to the vibrator side of the fuse and not to the heater lead (mark

CONDENSERS.

C1 ...	Air Trimmer.	C19 ...	11.5-366 pf.	F.C. sect. 3 gang.	C381 mfd.	T
C2 ...	10 pf. Silvered mica.	C201 mfd.	Tub. paper.	C391 mfd.	T
C3 ...	Air Trimmer.	C211 mfd.	Tub. paper.	C40 ...	20 pf.	S
C4 ...	6 pf. Silvered mica.	C22 ...	100 pf.	Silvered mica.	C41 ...	100 pf.	S
C5 ...	Air Trimmer.	C23 ...	3625 pf.	Silvered mica.	C42 ...	100 pf.	S
C6 ...	Air Trimmer.	C24 ...	2825 pf.	Silvered mica.	C4301 mfd.	M
C7 ...	11.5-366 pf. R.F. sect. 3 gang.	C25 ...	1040 pf.	Silvered mica.	C441 mfd.	T
C81 mfd. Tub. paper.	C26 ...	400 pf.	Silvered mica.	C4501 mfd.	M
C9 ...	100 pf. Silvered mica.	C27 ...		Air Trimmer.	C46 ...	25 mfd.	2
C101 mfd. Tub. paper.	C28 ...		Air Trimmer.	C47 ...	25 mfd.	2
C11 ...	20 pf. Silvered mica.	C29 ...		Air Trimmer.	C480003 mfd.	M
C12 ...	6 pf. Silvered mica.	C30 ...		Air Trimmer.	C495 mfd.	T
C13 ...	3 pf. Silvered mica.	C31 ...	11.5-366 pf.	Osc. sect. 3 gang.	C50005 mfd.	T
C1401 mfd. Tub. paper.	C32 ...	100 pf.	Silvered mica.	C515 mfd.	T
C15 ...	Air Trimmer.	C33 ...	100 pf.	Silvered mica.	C5202 mfd.	T
C16 ...	Air Trimmer.	C34 ...	100 pf.	Silvered mica.	C5301 mfd.	M
C17 ...	Air Trimmer.	C35 ...	100 pf.	Silvered mica.	C54 ...	8 mfd.	3
C18 ...	Air Trimmer.	C36 ...	100 pf.	Silvered mica.	C55 ...	32 mfd.	2
		C3701 mfd.	Tub. paper.	C565 mfd.	T

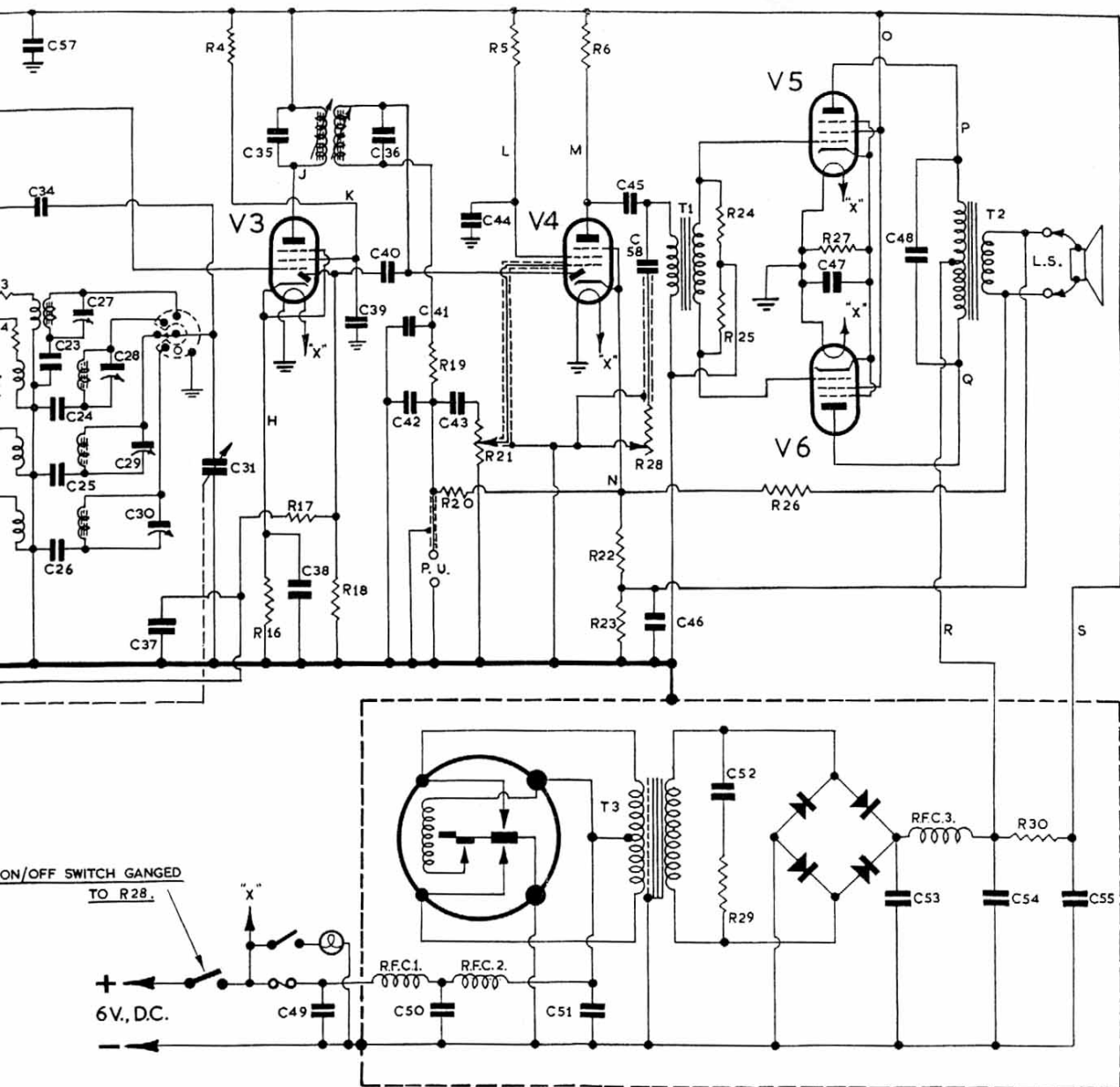

(marked X).

mf. Tub. paper.
 mf. Tub. paper.
 0 pf. Silvered mica.
 0 pf. Silvered mica.
 0 pf. Silvered mica.
 mf. Moulded mica.
 mf. Tub. paper.
 mf. Moulded Mica.
 mf. 25V. Tub. elect.
 mf. 25V. Tub. elect.
 mf. Moulded mica.
 mf. Tub. paper.
 mf. Tub. paper.
 mf. Tub. paper.
 mf. Tub. paper.
 mf. Moulded mica.
 mf. 350V. Tub. elect.
 mf. 200V. Tub. elect.
 mf. Tub. paper.

C5701 mfd. Moulded mica.
 C5801 mfd. Tub. paper.

RESISTORS.

R1 ... 47,000 ohms.
 R2 ... 22,000 ohms.
 R3 ... 10,000 ohms.
 R4 ... 47,000 ohms.
 R5 ... 1.0 Megohm.
 R627 Megohm.
 R747 Megohm.
 R8 ... 330 ohms.
 R947 Megohm.
 R10 ... 47,000 ohms.
 R11 ... 200 ohms, 10%.
 R12 ... 22,000 ohms.
 R13 ... 12 ohms.
 R14 ... 47 ohms.
 R15 ... 560 ohms.

R16 ... 1,000 ohms.
 R1747 Megohm.
 R1847 Megohm.
 R19 ... 22,000 ohms.
 R201 Megohm.
 R215 Megohm pot.
 R22 ... 22 ohms.
 R23 ... 2,700 ohms.
 R2447 Megohm.
 R2547 Megohm.
 R26 ... 220 ohms.
 R27 ... 390 ohms, 10%.
 R28 ... 50,000 ohms pot with switch.
 R29 ... 4,700 ohms.
 R30 ... 1,000 ohms.
 R31 ... 3,000 ohms.